

500 RETURN GRILLES & REGISTERS

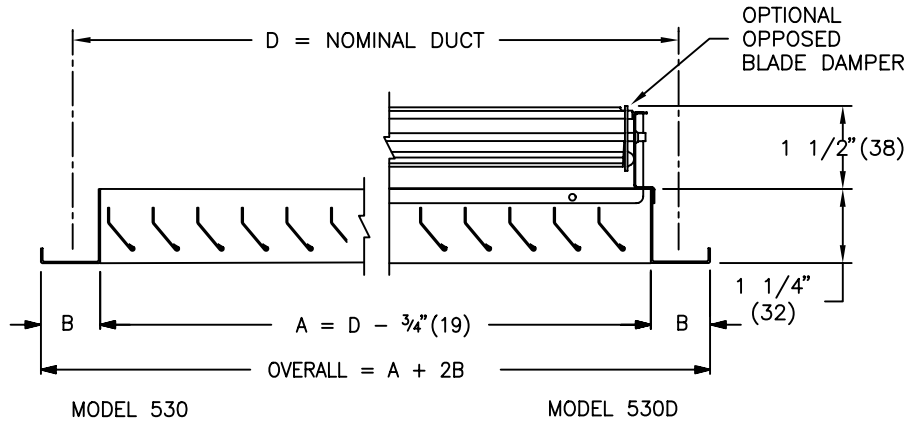

MATERIAL:

- STEEL CONSTRUCTION

FINISH:

- B12 WHITE (OPTIONAL FINISHES AVAILABLE)

OPTION:

- C/W COATED STEEL OPPOSED BLADE DAMPER (SPECIFY 530D OR 535D)

NOTE:

- TYPE A FASTENING - COUNTERSUNK SCREWHOLE FOR NO.8 S.M.S. PER FACTORY STANDARD (SCREWS SUPPLIED)
- AVAILABLE SIZES :
MIN. - 6" X 4" (152 X 102)
MAX. - 36" X 36" (914 X 914)
(ONE PIECE CONSTRUCTION)
- OVERSIZE UNITS AVAILABLE C/W DUCT MOUNTING CHANNEL
- BLADE ORIENTATION - FRONT SET
- L = PARALLEL TO LONG DIMENSION
- S = PARALLEL TO SHORT DIMENSION

CORE STYLES:

- 530/L
- 530/S

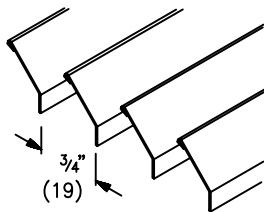

- 535/L
- 535/S

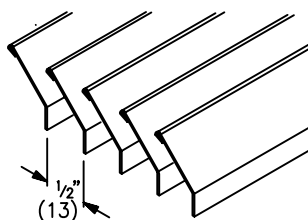

BORDERS:

F FLAT

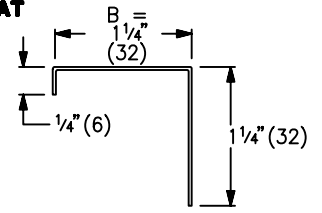

N NARROW

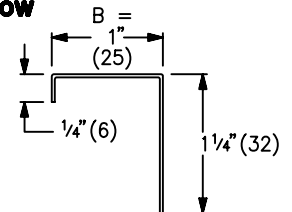

TB TEE BAR

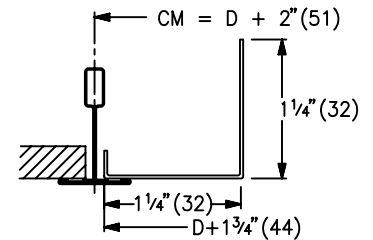

MOUNTING FRAMES:

D

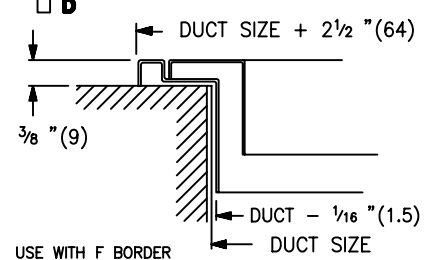

T

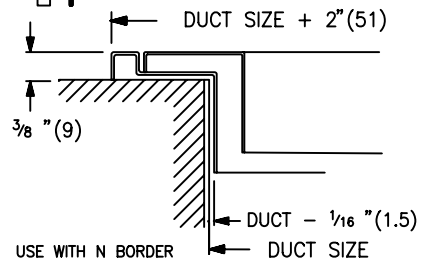

ALL METRIC DIMENSIONS () ARE SOFT CONVERTED. IMPERIAL DIMENSIONS ARE CONVERTED TO METRIC AND ROUNDED TO THE NEAREST MILLIMETER.

PROJECT:

ENGINEER:

CUSTOMER:

SUBMITTAL DATE:

SPEC. SYMBOL:

PRICE[®]

BW

530/535

219695

STEEL RETURN GRILLES & REGISTERS

NOV 2001