

500 SUPPLY GRILLES & REGISTERS

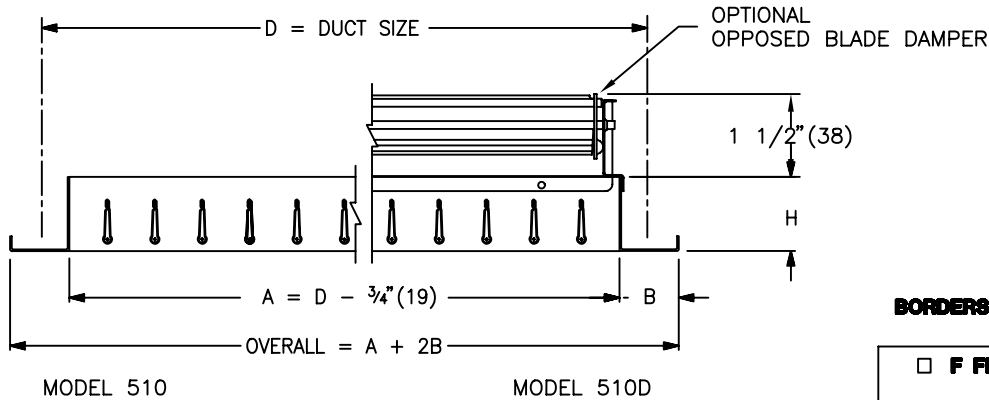

MATERIAL:

- STEEL CONSTRUCTION

FINISH:

- B12 WHITE (OPTIONAL FINISHES AVAILABLE)

OPTION:

- C/W COATED STEEL OPPOSED BLADE DAMPER (SPECIFY 510D OR 520D)

NOTE:

- STANDARD CONSTRUCTION WITH A MULLION: A MULLION IS PROVIDED WHEN NOMINAL SIZE GRILLE DIMENSIONS EXCEED 24" (610) FOR UNEVEN NOMINAL SIZE GRILLE DIMENSIONS EG. 45X6, THE MULLION IS POSITIONED 1/2" (12) FROM THE CENTRE OF THE GRILLE.
- LOUVRE BLADES - INDIVIDUALLY ADJUSTABLE
- TYPE A FASTENING - COUNTERSUNK SCREWHOLES FOR NO.8 S.M.S. PER FACTORY STANDARD (SCREWS SUPPLIED)
- AVAILABLE SIZES :
MIN. - 6" X 4" (152 X 102)
MAX. - 36" X 36" (914 X 914)
(ONE PIECE CONSTRUCTION)
- OVERSIZE UNITS AVAILABLE C/W NARROW FLANGE OR DUCT CHANNEL
- BLADE ORIENTATION - FRONT SET
- L = PARALLEL TO LONG DIMENSION
- S = PARALLEL TO SHORT DIMENSION

CORE STYLES:

- 510/L
- 510/S

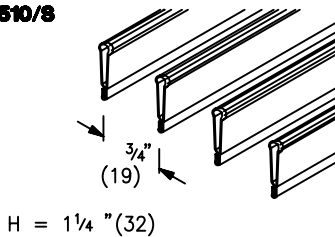

- 520/L
- 520/S

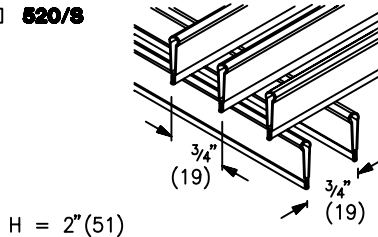

BORDERS:

F FLAT

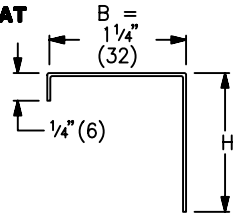

N NARROW

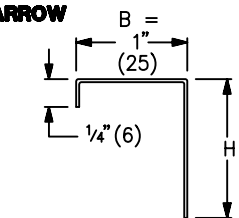

MOUNTING FRAMES:

D

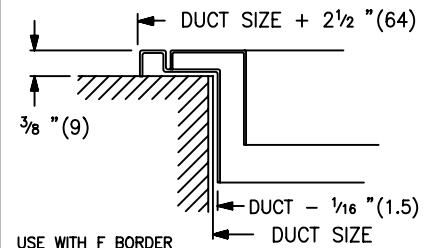

T

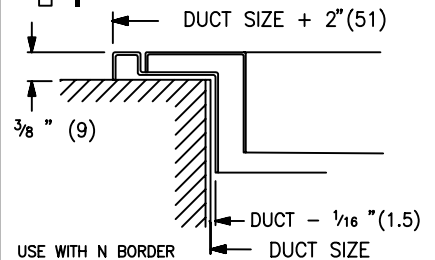

ALL METRIC DIMENSIONS () ARE SOFT CONVERTED. IMPERIAL DIMENSIONS ARE CONVERTED TO METRIC AND ROUNDED TO THE NEAREST MILLIMETER.

PROJECT:

ENGINEER:

CUSTOMER:

SUBMITTAL DATE:

SPEC. SYMBOL:



BW

219693

NOV 2001

510/520
STEEL SUPPLY
GRILLES & REGISTERS